

## FICHA TÉCNICA DATA SHEET FICHA TÉCNICA



### LED BATTEN IP65

#### Información general

Las pantallas Estancas LED de Filux consiguen que la instalación se realice sin tener que modificar el cableado. Su aplicación se extiende a cualquier espacio amplio, tanto interior como exterior. Todas las pantallas para tubos LED son estancas y cuentan con un diseño que facilita su montaje. Están fabricadas en materiales polímeros que aseguran su perdurabilidad en el tiempo.

#### General information

Filux Waterproof LED tri-proof ensure that the installation is done without having to modify the wiring. Its application extends to any ample space, both interior and exterior. All screens for LED tubes are watertight and have a design that facilitates their assembly. They are made of polymer materials that ensure their durability over time.

#### Informações gerais

As armaduras estanques LED Filux permitem que a sua instalação se faça sem modificar a cablagem. Sua aplicação é muito vast, podendo ser instalada em espaços interiores ou exteriores. As armaduras são fabricadas em materiais poliméricos que garantem a sua durabilidade no tempo.

**2**  
YEAR  
WARRANTY

**20.000H**

**CRI**  
>80

**110°**

**SP**  
>0,9KV

**IP65**

**IK06**

**A+**  
LABEL

**SMD**

**20 PCS**

0,45 kg

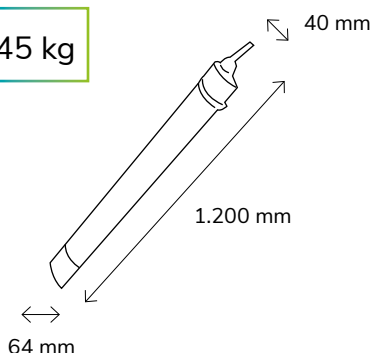

Model	Sku	Power	C.Temp	Lumens	Input
FT-1140	F1145	36W	5.000K	3.240	AC230V

Fotometría | Photometry | Fotometria

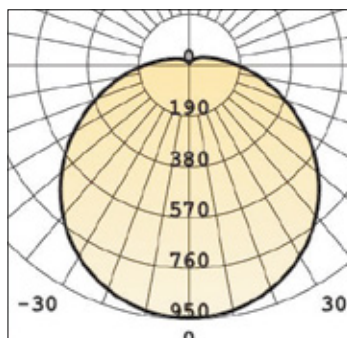

**110°** | Ángulo apertura  
Beam angle  
Ângulo de abertura