

The results reported herein have been performed in accordance with the terms of accreditation under the Singapore Accreditation Council (SAC).

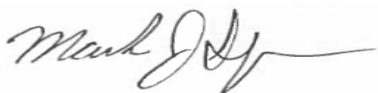

Mark Spencer
Quality and Reliability Engineer

Lumileds

IESNA LM-80 Test Report

1. Description of LED light sources tested

LUXEON 3030 2D: L130-3080003000W2C (nominal CCT 3000K)

2. Package Pictures

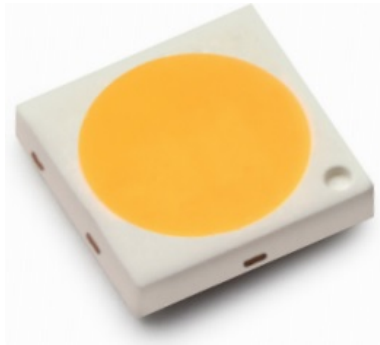

Figure 1. Picture of LUXEON 3030 2D.

3a. Projected L₇₀ extrapolations per IESNA TM-21-11

	If = 65mA	If = 100mA	If = 120mA
Ts = 105°C	216,700	-	156,296
Ts = 85°C	-	195,741	-
Ts = 55°C	300,318	-	-

3b. Reported L₇₀ extrapolations per IESNA TM-21-11

	If = 65mA	If = 100mA	If = 120mA
Ts = 105°C	> 36,000	-	> 36,000
Ts = 85°C	-	> 36,000	-
Ts = 55°C	> 36,000	-	-

4. Applicable LUXEON® Series part number(s)

This IESNA LM-80 Test Report applies to the following LUXEON part numbers:

Product Family	Part Number	CCT
LUXEON 3030 2D	L130-AABB003000W2C	white
LUXEON HR30	L130-AABBCCHR00000	white

For LUXEON 3030 2D: AA designates nominal CCT (22=2200K, 27=2700K, 30=3000K, 35=3500K, 40=4000K, 50=5000K, 57=5700K, 65=6500K), BB designates minimum CRI (70=70CRI, 80=80CRI and 90=90CRI), and C designates Lumileds internal code.

For LUXEON HR30: AA designates nominal CCT (22=2200K, 27=2700K, 30=3000K, 35=3500K, 40=4000K, 50=5000K, 57=5700K, 65=6500K), BB designates minimum CRI (70=70CRI, 80=80CRI and 90=90CRI), and CC designates ESD protection level (00=2kV and 0T=8kV).

5. Number of LED light sources tested

50 units tested per stress condition / data reported for 25 units per test condition.

6. Dates Tests Started

2016/08/24.

7. Date Report First Issued

2017/05/18.

8. Mechanical Drawing

For detailed mechanical drawings, please see individual product data sheets.

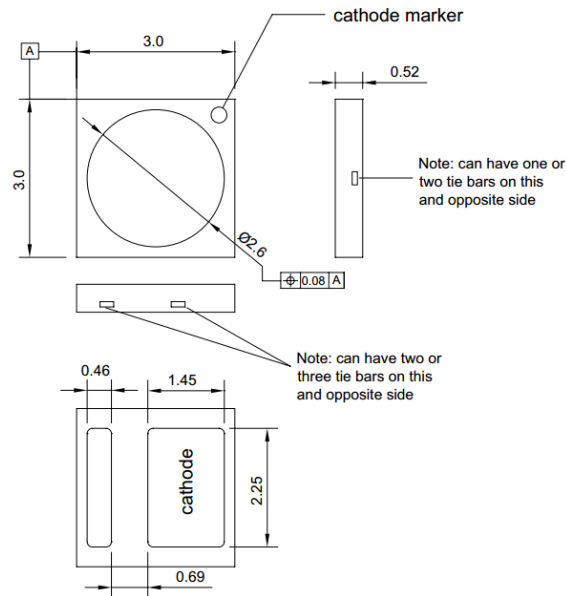

Figure 2: Mechanical Drawing for LUXEON 3030 2D. All dimensions are in millimeters.

9. T_s Measurement Point

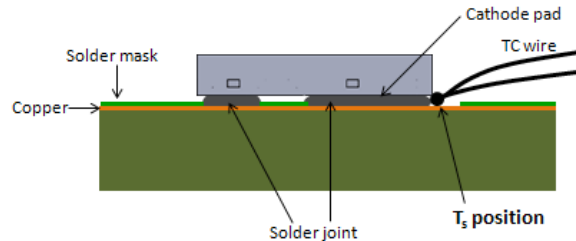

Figure 3: Preferred T_s measurement point for LUXEON 3030 2D.

For further information on measuring the in-situ T_s , please see Lumileds Application Brief AB207, which is available online at www.lumileds.com.

10. Description of auxiliary equipment

LUXEON LED devices are soldered to reliability stress boards.

Reliability stress boards are mounted in a chamber with minimal ambient airflow. The chamber temperature is controlled based on the temperature of a control T_s point, which is located on the stress board.

The reliability stress board is periodically removed from the thermal chamber, allowed to cool to room temperature, and then tested. After testing, the reliability stress board is returned to the thermal chamber for additional operation.

11. Operating Cycle

LUXEON LEDs are driven with a constant direct current (DC).

12. Ambient conditions including airflow, temperature, and relative humidity

The typical relative humidity within the chamber is < 65%. The temperature uniformity of the board (center to edge) was experimentally determined to be less than 2°C.

The photometry measurement temperature is set and monitored to be within 25°C ± 2°C with no forced airflow and RH < 65%.

13. T_s and ambient temperatures (ambient temperature measured 5mm above reliability stress board)

In all cases, both T_s and T_{air} meet or exceed the IESNA LM-80-08 limits.

14. Drive current of the LED light source during lifetime test

See tables.

15. Initial luminous flux and forward voltage at photometric measurement current

See tables.

16. Lumen maintenance for data for each individual light source along with median value, standard deviation, minimum and maximum lumen maintenance value for all of the light sources

See tables.

17. Observation of LED light source failures including the failure conditions and time of failure

No failures observed in devices reported.

18. LED light source monitoring interval

Units were tested at 0 hour and at subsequent 1,000 hours intervals.

19. Photometric measurement uncertainty

Long-term measurement uncertainty is based on reproducibility tests done over a period of one year, calculated to k = 2 coverage (i.e. 95% coverage).

Luminous Flux (Φ_v) ± 1.59%

Correlated Color Temperature (CCT) ± 21K

20. Chromaticity shift reported over the measurement time

See tables.

21. Sampling Method/Sample size

Please see Section 5.

22. ISO 17025-2005 Accreditation

Lumileds holds certificate LA-2016-0634-E issued by SAC-SINGLAS under scope of accreditation for IESNA LM-80-15 and LM-80-08.

Notes

Data is for reference only and is not an endorsement to exceed the Data Sheet operating conditions. The data was collected by a subcontracted laboratory (ref. R2SH160822052-10, R2SH160822053-10 and R2SH160822051-10).

The TM-21 extrapolations are based on IES TM-21-11 "Projecting Long Term Lumen Maintenance of LED Light Sources. The TM-21 lumen maintenance model is based on the flux data normalized to 1 at 0 hours and the use of an exponential model for flux(time):

Flux(time) = B exp[-alpha*time], where normally B ≅ 1, and alpha > 0.

An L70 extrapolation less than 0 means that the model predicts an increasing flux output with time, i.e. alpha < 0 (see graphs). Generally, this means that additional test time is needed to determine the long-term lumen maintenance behavior.

Disclaimer

Although LUMILEDS has attempted to provide the most accurate information and materials and services data (hereinafter "Data"), the Data is provided "as is" and may contain errors. The entire risk of use of the data shall be with the user. LUMILEDS makes no warranty, express or implied, including, but not limited to, the implied warranties of merchantability and fitness for a particular purpose, regarding the contents or correctness of the Data provided or the ability of the Data to meet the user's needs or expectations. LUMILEDS reserves the right to make changes without notice. You as user agree to this disclaimer and user agreement with the download or use of the provided materials and Data.

In no event shall LUMILEDS be liable for any direct, indirect, special, incidental, exemplary, or consequential damages arising out of or related to the use of the Data, however caused, regardless of theory of liability, and whether or not LUMILEDS has been advised of the possibility of such damage. This limitation shall apply notwithstanding any failure of essential purpose or any exclusive remedy.

Normalized Flux Statistics for I_f = 65mA

	0hrs	1000hrs	2000hrs	3000hrs	4000hrs	5000hrs	6000hrs	alpha	B	L70
median =	1.000	1.002	1.000	0.999	0.997	0.995	0.993			
Ts=Tair=105°C average =	1.000	1.002	1.000	0.999	0.997	0.995	0.993	1.6621e-06	1.0035	216,700
st dev =	0.000	0.001	0.001	0.001	0.001	0.002	0.001	TM-21 L70(6k) > 36,000hrs		
min =	1.000	1.000	0.998	0.997	0.994	0.993	0.991			
max =	1.000	1.003	1.002	1.001	1.000	0.999	0.997			
median =	1.000	1.004	1.003	1.002	1.000	0.999	0.997			
Ts=Tair=55°C average =	1.000	1.003	1.003	1.002	1.000	0.999	0.998	1.2044e-06	1.0050	300,318
st dev =	0.000	0.001	0.001	0.001	0.001	0.001	0.001	TM-21 L70(6k) > 36,000hrs		
min =	1.000	1.001	1.000	1.000	0.999	0.997	0.995			
max =	1.000	1.005	1.004	1.004	1.002	1.001	0.999			

Lumen Maintenance for $I_f = 65\text{mA}$
Normalized to 1 at 0 hours

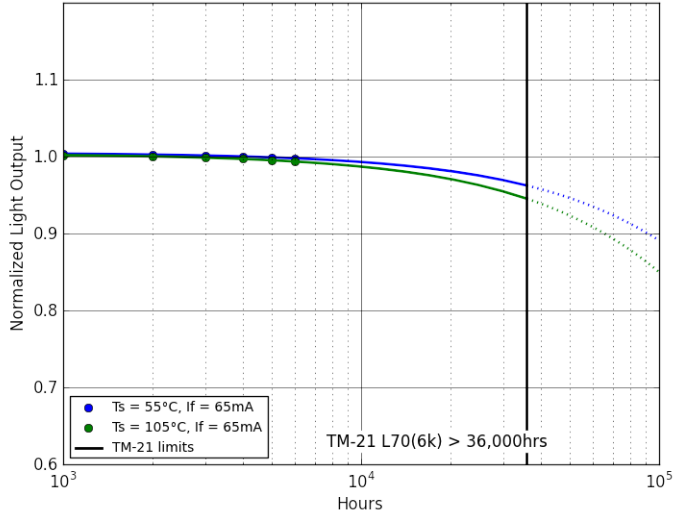

Delta u'v' for $I_f = 65\text{mA}$

	0hrs	1000hrs	2000hrs	3000hrs	4000hrs	5000hrs	6000hrs
median =	0.0000	0.0004	0.0007	0.0009	0.0013	0.0014	0.0013
$T_s=T_{air}=105^\circ\text{C}$ average =	0.0000	0.0004	0.0007	0.0008	0.0013	0.0015	0.0013
st dev =	0.0000	0.0001	0.0001	0.0001	0.0001	0.0001	0.0001
min =	0.0000	0.0002	0.0005	0.0007	0.0011	0.0013	0.0011
max =	0.0000	0.0006	0.0009	0.0010	0.0014	0.0017	0.0014
median =	0.0000	0.0003	0.0004	0.0005	0.0010	0.0012	0.0014
$T_s=T_{air}=55^\circ\text{C}$ average =	0.0000	0.0003	0.0004	0.0005	0.0010	0.0013	0.0015
st dev =	0.0000	0.0002	0.0002	0.0002	0.0002	0.0002	0.0002
min =	0.0000	0.0001	0.0003	0.0003	0.0008	0.0011	0.0012
max =	0.0000	0.0009	0.0010	0.0010	0.0017	0.0019	0.0021

Normalized Flux Statistics for $I_f = 100\text{mA}$

	0hrs	1000hrs	2000hrs	3000hrs	4000hrs	5000hrs	6000hrs	alpha	B	L70
median =	1.000	0.998	0.996	0.995	0.994	0.992	0.989			
Ts=Tair=85°C average =	1.000	0.999	0.997	0.995	0.994	0.992	0.989	1.8250e-06	1.0006	195,741
st dev =	0.000	0.002	0.002	0.002	0.002	0.002	0.002	TM-21 L70(6k) > 36,000hrs		
min =	1.000	0.996	0.994	0.992	0.991	0.988	0.986			
max =	1.000	1.003	1.002	0.999	0.998	0.996	0.994			

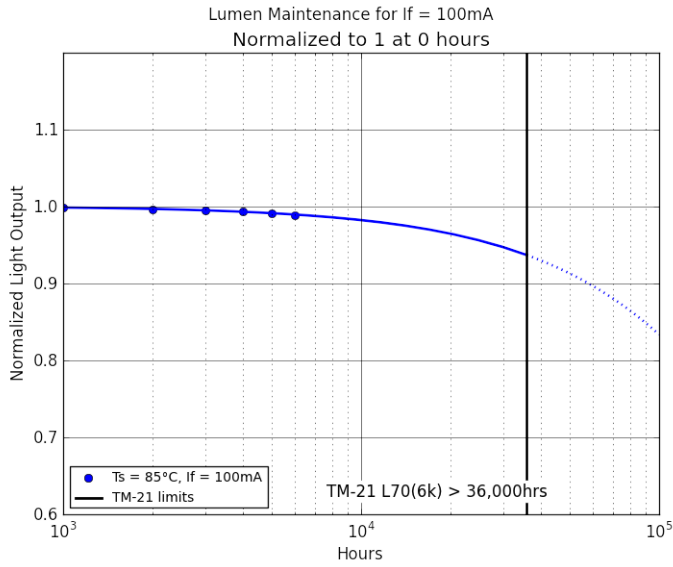

Delta u'v' for $I_f = 100\text{mA}$

	0hrs	1000hrs	2000hrs	3000hrs	4000hrs	5000hrs	6000hrs
median =	0.0000	0.0005	0.0007	0.0009	0.0012	0.0014	0.0017
Ts=Tair=85°C average =	0.0000	0.0005	0.0007	0.0009	0.0012	0.0014	0.0017
st dev =	0.0000	0.0002	0.0001	0.0001	0.0002	0.0002	0.0003
min =	0.0000	0.0002	0.0005	0.0007	0.0010	0.0012	0.0013
max =	0.0000	0.0009	0.0011	0.0014	0.0017	0.0020	0.0022

Normalized Flux Statistics for $I_f = 120\text{mA}$

	0hrs	1000hrs	2000hrs	3000hrs	4000hrs	5000hrs	6000hrs	alpha	B	L70
median =	1.000	0.998	0.996	0.994	0.992	0.989	0.987			
Ts=Tair=105°C average =	1.000	0.999	0.996	0.994	0.992	0.990	0.987	2.2874e-06	1.0008	156,296
st dev =	0.000	0.002	0.002	0.002	0.002	0.002	0.002	TM-21 L70(6k) > 36,000hrs		
min =	1.000	0.995	0.993	0.991	0.989	0.986	0.983			
max =	1.000	1.002	0.998	0.998	0.995	0.994	0.992			

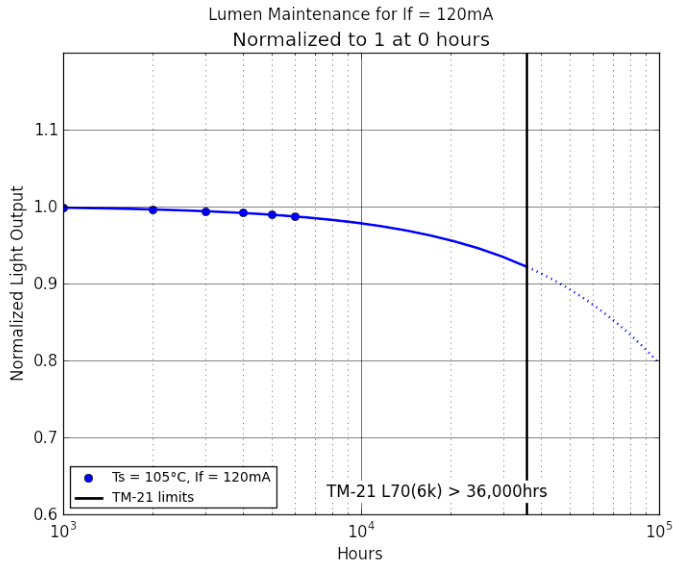

Delta u'v' for $I_f = 120\text{mA}$

	0hrs	1000hrs	2000hrs	3000hrs	4000hrs	5000hrs	6000hrs
median =	0.0000	0.0006	0.0007	0.0011	0.0013	0.0017	0.0019
Ts=Tair=105°C average =	0.0000	0.0006	0.0008	0.0011	0.0013	0.0017	0.0019
st dev =	0.0000	0.0002	0.0002	0.0002	0.0003	0.0003	0.0002
min =	0.0000	0.0002	0.0006	0.0009	0.0008	0.0012	0.0017
max =	0.0000	0.0013	0.0014	0.0020	0.0024	0.0027	0.0028

Luminous Flux [lm] data for tested units

$T_s = T_{air} = 55^{\circ}\text{C}$, $I_f = 65\text{mA}$; $T_s \geq 53^{\circ}\text{C}$ and $T_{air} \geq 50^{\circ}\text{C}$ in compliance with LM-80-15

	CCT (t=0)	0hrs	1000hrs	2000hrs	3000hrs	4000hrs	5000hrs	6000hrs
1	3117K	72.490	72.770	72.730	72.720	72.600	72.450	72.370
2	3115K	72.320	72.550	72.490	72.410	72.300	72.250	72.230
3	3106K	72.840	72.940	72.910	72.830	72.760	72.670	72.630
4	3104K	72.790	73.130	73.080	73.070	72.920	72.850	72.730
5	3088K	73.240	73.430	73.290	73.220	73.200	73.090	72.970
6	3123K	72.120	72.470	72.440	72.380	72.260	72.200	72.030
7	3085K	72.660	72.930	72.850	72.840	72.630	72.620	72.470
8	3126K	72.960	73.220	73.140	73.030	72.990	72.880	72.750
9	3101K	73.140	73.430	73.370	73.340	73.190	73.150	73.050
10	3139K	73.820	74.200	74.100	74.040	73.960	73.930	73.710
11	3106K	73.070	73.340	73.260	73.160	73.150	73.050	72.870
12	3134K	70.820	71.090	71.020	70.890	70.850	70.750	70.580
13	3124K	70.900	71.140	71.090	71.080	70.980	70.890	70.820
14	3136K	72.000	72.220	72.160	72.130	71.970	71.810	71.770
15	3107K	73.470	73.570	73.500	73.440	73.390	73.270	73.110
16	3100K	72.310	72.570	72.460	72.400	72.300	72.170	72.090
17	3117K	72.930	73.210	73.150	73.080	72.980	72.870	72.680
18	3098K	73.160	73.390	73.320	73.230	73.120	73.060	72.880
19	3142K	71.640	72.010	71.960	71.900	71.780	71.670	71.570
20	3103K	73.540	73.810	73.710	73.650	73.560	73.350	73.330
21	3105K	72.790	73.100	73.080	73.060	72.860	72.780	72.660
22	3121K	72.370	72.540	72.480	72.420	72.380	72.230	72.150
23	2965K	73.800	74.000	73.980	73.880	73.760	73.650	73.550
24	3101K	73.060	73.330	73.280	73.240	73.080	73.030	72.910
25	3104K	70.290	70.470	70.460	70.450	70.270	70.110	70.090

Normalized Luminous Flux data for tested units

$T_s = T_{air} = 55^{\circ}\text{C}$, $I_f = 65\text{mA}$; $T_s \geq 53^{\circ}\text{C}$ and $T_{air} \geq 50^{\circ}\text{C}$ in compliance with LM-80-15

	CCT (t=0)	0hrs	1000hrs	2000hrs	3000hrs	4000hrs	5000hrs	6000hrs
1	3117K	1.000	1.004	1.003	1.003	1.002	0.999	0.998
2	3115K	1.000	1.003	1.002	1.001	1.000	0.999	0.999
3	3106K	1.000	1.001	1.001	1.000	0.999	0.998	0.997
4	3104K	1.000	1.005	1.004	1.004	1.002	1.001	0.999
5	3088K	1.000	1.003	1.001	1.000	0.999	0.998	0.996
6	3123K	1.000	1.005	1.004	1.004	1.002	1.001	0.999
7	3085K	1.000	1.004	1.003	1.002	1.000	0.999	0.997
8	3126K	1.000	1.004	1.002	1.001	1.000	0.999	0.997
9	3101K	1.000	1.004	1.003	1.003	1.001	1.000	0.999
10	3139K	1.000	1.005	1.004	1.003	1.002	1.001	0.999
11	3106K	1.000	1.004	1.003	1.001	1.001	1.000	0.997
12	3134K	1.000	1.004	1.003	1.001	1.000	0.999	0.997
13	3124K	1.000	1.003	1.003	1.003	1.001	1.000	0.999
14	3136K	1.000	1.003	1.002	1.002	1.000	0.997	0.997
15	3107K	1.000	1.001	1.000	1.000	0.999	0.997	0.995
16	3100K	1.000	1.004	1.002	1.001	1.000	0.998	0.997
17	3117K	1.000	1.004	1.003	1.002	1.001	0.999	0.997
18	3098K	1.000	1.003	1.002	1.001	0.999	0.999	0.996
19	3142K	1.000	1.005	1.004	1.004	1.002	1.000	0.999
20	3103K	1.000	1.004	1.002	1.001	1.000	0.997	0.997
21	3105K	1.000	1.004	1.004	1.004	1.001	1.000	0.998
22	3121K	1.000	1.002	1.002	1.001	1.000	0.998	0.997
23	2965K	1.000	1.003	1.002	1.001	0.999	0.998	0.997
24	3101K	1.000	1.004	1.003	1.002	1.000	1.000	0.998
25	3104K	1.000	1.003	1.002	1.002	1.000	0.997	0.997

CIE 1976 u' data for tested units

$T_s = T_{air} = 55^{\circ}\text{C}$, $I_f = 65\text{mA}$; $T_s \geq 53^{\circ}\text{C}$ and $T_{air} \geq 50^{\circ}\text{C}$ in compliance with LM-80-15

	CCT (t=0)	0hrs	1000hrs	2000hrs	3000hrs	4000hrs	5000hrs	6000hrs
1	3117K	0.2469	0.2467	0.2469	0.2468	0.2465	0.2464	0.2466
2	3115K	0.2467	0.2463	0.2465	0.2462	0.2460	0.2459	0.2461
3	3106K	0.2473	0.2471	0.2472	0.2470	0.2468	0.2466	0.2469
4	3104K	0.2472	0.2469	0.2471	0.2470	0.2466	0.2466	0.2468
5	3088K	0.2480	0.2478	0.2480	0.2479	0.2476	0.2475	0.2477
6	3123K	0.2465	0.2463	0.2464	0.2464	0.2460	0.2459	0.2462
7	3085K	0.2481	0.2478	0.2480	0.2479	0.2476	0.2473	0.2477
8	3126K	0.2465	0.2463	0.2464	0.2463	0.2460	0.2459	0.2461
9	3101K	0.2471	0.2468	0.2470	0.2469	0.2466	0.2465	0.2467
10	3139K	0.2463	0.2460	0.2461	0.2460	0.2457	0.2456	0.2459
11	3106K	0.2473	0.2471	0.2473	0.2473	0.2468	0.2467	0.2471
12	3134K	0.2463	0.2462	0.2463	0.2463	0.2458	0.2458	0.2461
13	3124K	0.2465	0.2459	0.2460	0.2461	0.2455	0.2454	0.2459
14	3136K	0.2457	0.2455	0.2456	0.2456	0.2452	0.2451	0.2454
15	3107K	0.2470	0.2467	0.2468	0.2467	0.2463	0.2465	0.2467
16	3100K	0.2473	0.2471	0.2472	0.2471	0.2467	0.2469	0.2470
17	3117K	0.2469	0.2467	0.2467	0.2466	0.2462	0.2464	0.2466
18	3098K	0.2473	0.2471	0.2472	0.2471	0.2468	0.2469	0.2471
19	3142K	0.2456	0.2454	0.2455	0.2455	0.2451	0.2452	0.2454
20	3103K	0.2476	0.2474	0.2474	0.2474	0.2471	0.2472	0.2473
21	3105K	0.2472	0.2471	0.2472	0.2472	0.2468	0.2469	0.2471
22	3121K	0.2464	0.2462	0.2463	0.2462	0.2459	0.2460	0.2461
23	2965K	0.2512	0.2509	0.2511	0.2510	0.2506	0.2508	0.2509
24	3101K	0.2475	0.2473	0.2475	0.2474	0.2471	0.2472	0.2474
25	3104K	0.2476	0.2473	0.2474	0.2474	0.2470	0.2471	0.2473

CIE 1976 v' data for tested units

$T_s = T_{air} = 55^{\circ}\text{C}$, $I_f = 65\text{mA}$; $T_s \geq 53^{\circ}\text{C}$ and $T_{air} \geq 50^{\circ}\text{C}$ in compliance with LM-80-15

	CCT (t=0)	0hrs	1000hrs	2000hrs	3000hrs	4000hrs	5000hrs	6000hrs
1	3117K	0.5179	0.5178	0.5176	0.5174	0.5170	0.5168	0.5164
2	3115K	0.5189	0.5185	0.5184	0.5182	0.5179	0.5177	0.5172
3	3106K	0.5179	0.5177	0.5175	0.5174	0.5170	0.5168	0.5164
4	3104K	0.5185	0.5182	0.5180	0.5179	0.5175	0.5174	0.5169
5	3088K	0.5179	0.5178	0.5176	0.5175	0.5171	0.5169	0.5165
6	3123K	0.5185	0.5182	0.5181	0.5179	0.5175	0.5174	0.5169
7	3085K	0.5179	0.5177	0.5175	0.5174	0.5170	0.5168	0.5163
8	3126K	0.5181	0.5179	0.5177	0.5176	0.5172	0.5171	0.5166
9	3101K	0.5193	0.5191	0.5189	0.5189	0.5185	0.5183	0.5179
10	3139K	0.5170	0.5167	0.5165	0.5165	0.5161	0.5159	0.5155
11	3106K	0.5179	0.5178	0.5175	0.5175	0.5171	0.5169	0.5166
12	3134K	0.5177	0.5175	0.5174	0.5173	0.5169	0.5167	0.5163
13	3124K	0.5184	0.5177	0.5175	0.5175	0.5170	0.5168	0.5164
14	3136K	0.5195	0.5194	0.5192	0.5191	0.5187	0.5186	0.5183
15	3107K	0.5188	0.5185	0.5183	0.5182	0.5178	0.5177	0.5174
16	3100K	0.5187	0.5185	0.5183	0.5182	0.5178	0.5176	0.5173
17	3117K	0.5178	0.5174	0.5172	0.5170	0.5167	0.5164	0.5162
18	3098K	0.5191	0.5190	0.5188	0.5185	0.5182	0.5179	0.5177
19	3142K	0.5191	0.5190	0.5188	0.5188	0.5184	0.5181	0.5178
20	3103K	0.5172	0.5170	0.5168	0.5168	0.5164	0.5160	0.5158
21	3105K	0.5184	0.5183	0.5180	0.5180	0.5176	0.5173	0.5170
22	3121K	0.5191	0.5189	0.5187	0.5186	0.5183	0.5180	0.5177
23	2965K	0.5245	0.5243	0.5240	0.5240	0.5237	0.5233	0.5231
24	3101K	0.5179	0.5178	0.5176	0.5175	0.5172	0.5168	0.5166
25	3104K	0.5171	0.5169	0.5167	0.5167	0.5163	0.5159	0.5158

Delta u'v' data for tested units

$T_s = T_{air} = 55^\circ\text{C}$, $I_f = 65\text{mA}$; $T_s \geq 53^\circ\text{C}$ and $T_{air} \geq 50^\circ\text{C}$ in compliance with LM-80-15

	CCT (t=0)	0hrs	1000hrs	2000hrs	3000hrs	4000hrs	5000hrs	6000hrs
1	3117K	0.0000	0.0002	0.0003	0.0005	0.0010	0.0012	0.0015
2	3115K	0.0000	0.0006	0.0005	0.0009	0.0012	0.0014	0.0018
3	3106K	0.0000	0.0003	0.0004	0.0006	0.0010	0.0013	0.0016
4	3104K	0.0000	0.0004	0.0005	0.0006	0.0012	0.0013	0.0016
5	3088K	0.0000	0.0002	0.0003	0.0004	0.0009	0.0011	0.0014
6	3123K	0.0000	0.0004	0.0004	0.0006	0.0011	0.0013	0.0016
7	3085K	0.0000	0.0004	0.0004	0.0005	0.0010	0.0014	0.0016
8	3126K	0.0000	0.0003	0.0004	0.0005	0.0010	0.0012	0.0016
9	3101K	0.0000	0.0004	0.0004	0.0004	0.0009	0.0012	0.0015
10	3139K	0.0000	0.0004	0.0005	0.0006	0.0011	0.0013	0.0016
11	3106K	0.0000	0.0002	0.0004	0.0004	0.0009	0.0012	0.0013
12	3134K	0.0000	0.0002	0.0003	0.0004	0.0009	0.0011	0.0014
13	3124K	0.0000	0.0009	0.0010	0.0010	0.0017	0.0019	0.0021
14	3136K	0.0000	0.0002	0.0003	0.0004	0.0009	0.0011	0.0012
15	3107K	0.0000	0.0004	0.0005	0.0007	0.0012	0.0012	0.0014
16	3100K	0.0000	0.0003	0.0004	0.0005	0.0011	0.0012	0.0014
17	3117K	0.0000	0.0004	0.0006	0.0009	0.0013	0.0015	0.0016
18	3098K	0.0000	0.0002	0.0003	0.0006	0.0010	0.0013	0.0014
19	3142K	0.0000	0.0002	0.0003	0.0003	0.0009	0.0011	0.0013
20	3103K	0.0000	0.0003	0.0004	0.0004	0.0009	0.0013	0.0014
21	3105K	0.0000	0.0001	0.0004	0.0004	0.0009	0.0011	0.0014
22	3121K	0.0000	0.0003	0.0004	0.0005	0.0009	0.0012	0.0014
23	2965K	0.0000	0.0004	0.0005	0.0005	0.0010	0.0013	0.0014
24	3101K	0.0000	0.0002	0.0003	0.0004	0.0008	0.0011	0.0013
25	3104K	0.0000	0.0004	0.0004	0.0004	0.0010	0.0013	0.0013

Forward Voltage [V] data for tested units

$T_s = T_{air} = 55^\circ\text{C}$, $I_f = 65\text{mA}$; $T_s \geq 53^\circ\text{C}$ and $T_{air} \geq 50^\circ\text{C}$ in compliance with LM-80-15

	CCT (t=0)	0hrs	1000hrs	2000hrs	3000hrs	4000hrs	5000hrs	6000hrs
1	3117K	5.546	5.548	5.556	5.553	5.551	5.546	5.553
2	3115K	5.577	5.584	5.582	5.588	5.584	5.575	5.599
3	3106K	5.642	5.620	5.613	5.620	5.616	5.611	5.620
4	3104K	5.602	5.602	5.597	5.606	5.678	5.597	5.601
5	3088K	5.705	5.611	5.603	5.607	5.602	5.596	5.605
6	3123K	5.567	5.584	5.568	5.579	5.573	5.577	5.575
7	3085K	5.565	5.568	5.570	5.582	5.571	5.607	5.576
8	3126K	5.595	5.595	5.596	5.611	5.601	5.598	5.596
9	3101K	5.602	5.567	5.559	5.587	5.568	5.561	5.563
10	3139K	5.697	5.744	5.615	5.627	5.616	5.676	5.616
11	3106K	5.580	5.627	5.577	5.586	5.581	5.637	5.577
12	3134K	5.606	5.566	5.567	5.576	5.570	5.568	5.566
13	3124K	5.589	5.591	5.595	5.607	5.640	5.705	5.594
14	3136K	5.601	5.587	5.585	5.595	5.589	5.583	5.587
15	3107K	5.575	5.577	5.575	5.584	5.585	5.586	5.581
16	3100K	5.577	5.728	5.555	5.566	5.557	5.562	5.558
17	3117K	5.593	5.594	5.598	5.607	5.600	5.612	5.595
18	3098K	5.566	5.568	5.567	5.577	5.572	5.572	5.572
19	3142K	5.797	5.610	5.595	5.646	5.596	5.637	5.592
20	3103K	5.593	5.603	5.597	5.606	5.598	5.646	5.601
21	3105K	5.578	5.580	5.582	5.590	5.593	5.586	5.582
22	3121K	5.574	5.574	5.575	5.583	5.577	5.576	5.575
23	2965K	5.599	5.603	5.609	5.611	5.832	5.602	5.599
24	3101K	5.576	5.601	5.593	5.587	5.585	5.582	5.588
25	3104K	5.595	5.602	5.593	5.608	5.598	5.614	5.596

Luminous Flux [lm] data for tested units

$T_s = T_{air} = 105^{\circ}\text{C}$, $I_f = 65\text{mA}$; $T_s \geq 103^{\circ}\text{C}$ and $T_{air} \geq 100^{\circ}\text{C}$ in compliance with LM-80-15

	CCT (t=0)	0hrs	1000hrs	2000hrs	3000hrs	4000hrs	5000hrs	6000hrs
1	3114K	73.390	73.610	73.550	73.500	73.360	73.310	73.170
2	3090K	72.100	72.280	72.150	72.110	72.040	71.800	71.690
3	3109K	73.490	73.600	73.500	73.380	73.210	73.040	72.910
4	3118K	73.570	73.710	73.590	73.480	73.300	73.220	73.010
5	2947K	73.070	73.160	73.020	72.910	72.700	72.650	72.520
6	3104K	72.430	72.580	72.550	72.480	72.330	72.210	71.970
7	2920K	71.660	71.790	71.550	71.540	71.420	71.300	71.100
8	3117K	73.240	73.390	73.310	73.230	73.120	72.910	72.810
9	3117K	70.540	70.590	70.420	70.390	70.320	70.260	70.110
10	3126K	71.440	71.550	71.420	71.240	71.090	70.970	70.940
11	3089K	72.030	72.070	71.990	71.820	71.670	71.500	71.420
12	3091K	71.480	71.600	71.470	71.330	71.270	71.210	70.990
13	3127K	70.920	71.140	71.040	70.990	70.870	70.700	70.620
14	3117K	71.880	72.080	71.930	71.830	71.800	71.670	71.520
15	3085K	72.680	72.820	72.660	72.560	72.490	72.380	72.230
16	3096K	71.200	71.270	71.160	71.050	70.950	70.760	70.670
17	3106K	73.460	73.470	73.400	73.290	73.240	73.120	72.990
18	3081K	72.870	72.900	72.820	72.690	72.630	72.480	72.320
19	3100K	72.430	72.480	72.370	72.210	72.030	71.890	71.820
20	3082K	71.610	71.680	71.590	71.460	71.370	71.200	70.970
21	2961K	73.470	73.620	73.460	73.380	73.340	73.120	72.890
22	3101K	72.680	72.840	72.620	72.580	72.430	72.260	72.080
23	3099K	72.430	72.560	72.420	72.390	72.270	72.100	71.910
24	3121K	72.650	72.860	72.820	72.730	72.590	72.500	72.350
25	3107K	72.460	72.570	72.470	72.370	72.240	72.120	71.940

Normalized Luminous Flux data for tested units

$T_s = T_{air} = 105^{\circ}\text{C}$, $I_f = 65\text{mA}$; $T_s \geq 103^{\circ}\text{C}$ and $T_{air} \geq 100^{\circ}\text{C}$ in compliance with LM-80-15

	CCT (t=0)	0hrs	1000hrs	2000hrs	3000hrs	4000hrs	5000hrs	6000hrs
1	3114K	1.000	1.003	1.002	1.001	1.000	0.999	0.997
2	3090K	1.000	1.002	1.001	1.000	0.999	0.996	0.994
3	3109K	1.000	1.001	1.000	0.999	0.996	0.994	0.992
4	3118K	1.000	1.002	1.000	0.999	0.996	0.995	0.992
5	2947K	1.000	1.001	0.999	0.998	0.995	0.994	0.992
6	3104K	1.000	1.002	1.002	1.001	0.999	0.997	0.994
7	2920K	1.000	1.002	0.998	0.998	0.997	0.995	0.992
8	3117K	1.000	1.002	1.001	1.000	0.998	0.995	0.994
9	3117K	1.000	1.001	0.998	0.998	0.997	0.996	0.994
10	3126K	1.000	1.002	1.000	0.997	0.995	0.993	0.993
11	3089K	1.000	1.001	0.999	0.997	0.995	0.993	0.992
12	3091K	1.000	1.002	1.000	0.998	0.997	0.996	0.993
13	3127K	1.000	1.003	1.002	1.001	0.999	0.997	0.996
14	3117K	1.000	1.003	1.001	0.999	0.999	0.997	0.995
15	3085K	1.000	1.002	1.000	0.998	0.997	0.996	0.994
16	3096K	1.000	1.001	0.999	0.998	0.996	0.994	0.993
17	3106K	1.000	1.000	0.999	0.998	0.997	0.995	0.994
18	3081K	1.000	1.000	0.999	0.998	0.997	0.995	0.992
19	3100K	1.000	1.001	0.999	0.997	0.994	0.993	0.992
20	3082K	1.000	1.001	1.000	0.998	0.997	0.994	0.991
21	2961K	1.000	1.002	1.000	0.999	0.998	0.995	0.992
22	3101K	1.000	1.002	0.999	0.999	0.997	0.994	0.992
23	3099K	1.000	1.002	1.000	0.999	0.998	0.995	0.993
24	3121K	1.000	1.003	1.002	1.001	0.999	0.998	0.996
25	3107K	1.000	1.002	1.000	0.999	0.997	0.995	0.993

CIE 1976 u' data for tested units

$T_s = T_{air} = 105^{\circ}\text{C}$, $I_f = 65\text{mA}$; $T_s \geq 103^{\circ}\text{C}$ and $T_{air} \geq 100^{\circ}\text{C}$ in compliance with LM-80-15

	CCT (t=0)	0hrs	1000hrs	2000hrs	3000hrs	4000hrs	5000hrs	6000hrs
1	3114K	0.2464	0.2461	0.2462	0.2461	0.2456	0.2459	0.2456
2	3090K	0.2481	0.2477	0.2478	0.2478	0.2474	0.2476	0.2474
3	3109K	0.2472	0.2469	0.2470	0.2470	0.2465	0.2467	0.2465
4	3118K	0.2468	0.2465	0.2466	0.2465	0.2461	0.2463	0.2461
5	2947K	0.2519	0.2515	0.2516	0.2515	0.2511	0.2513	0.2511
6	3104K	0.2474	0.2471	0.2472	0.2471	0.2467	0.2469	0.2467
7	2920K	0.2538	0.2535	0.2536	0.2535	0.2530	0.2533	0.2530
8	3117K	0.2467	0.2463	0.2464	0.2463	0.2458	0.2461	0.2458
9	3117K	0.2468	0.2467	0.2467	0.2465	0.2461	0.2464	0.2461
10	3126K	0.2470	0.2467	0.2468	0.2467	0.2463	0.2464	0.2463
11	3089K	0.2481	0.2478	0.2478	0.2478	0.2474	0.2476	0.2474
12	3091K	0.2477	0.2475	0.2475	0.2475	0.2470	0.2472	0.2470
13	3127K	0.2461	0.2458	0.2459	0.2458	0.2454	0.2456	0.2454
14	3117K	0.2459	0.2456	0.2456	0.2455	0.2452	0.2454	0.2452
15	3085K	0.2480	0.2476	0.2477	0.2477	0.2472	0.2474	0.2472
16	3096K	0.2477	0.2473	0.2474	0.2474	0.2469	0.2471	0.2469
17	3106K	0.2473	0.2470	0.2470	0.2470	0.2465	0.2468	0.2465
18	3081K	0.2482	0.2479	0.2480	0.2479	0.2474	0.2477	0.2474
19	3100K	0.2473	0.2469	0.2470	0.2469	0.2464	0.2466	0.2464
20	3082K	0.2483	0.2480	0.2481	0.2480	0.2476	0.2477	0.2476
21	2961K	0.2517	0.2513	0.2515	0.2514	0.2508	0.2510	0.2508
22	3101K	0.2474	0.2471	0.2471	0.2470	0.2466	0.2467	0.2466
23	3099K	0.2479	0.2476	0.2477	0.2476	0.2472	0.2473	0.2472
24	3121K	0.2471	0.2467	0.2468	0.2467	0.2463	0.2465	0.2463
25	3107K	0.2474	0.2471	0.2471	0.2470	0.2466	0.2467	0.2466

CIE 1976 v' data for tested units

$T_s = T_{air} = 105^{\circ}\text{C}$, $I_f = 65\text{mA}$; $T_s \geq 103^{\circ}\text{C}$ and $T_{air} \geq 100^{\circ}\text{C}$ in compliance with LM-80-15

	CCT (t=0)	0hrs	1000hrs	2000hrs	3000hrs	4000hrs	5000hrs	6000hrs
1	3114K	0.5200	0.5197	0.5195	0.5192	0.5191	0.5187	0.5191
2	3090K	0.5172	0.5170	0.5166	0.5164	0.5162	0.5159	0.5162
3	3109K	0.5179	0.5176	0.5173	0.5172	0.5169	0.5166	0.5169
4	3118K	0.5181	0.5178	0.5175	0.5173	0.5170	0.5168	0.5170
5	2947K	0.5247	0.5244	0.5240	0.5239	0.5237	0.5234	0.5237
6	3104K	0.5178	0.5175	0.5171	0.5170	0.5167	0.5164	0.5167
7	2920K	0.5216	0.5213	0.5209	0.5208	0.5205	0.5202	0.5205
8	3117K	0.5186	0.5182	0.5179	0.5177	0.5175	0.5172	0.5175
9	3117K	0.5182	0.5180	0.5177	0.5175	0.5172	0.5169	0.5172
10	3126K	0.5163	0.5159	0.5156	0.5155	0.5152	0.5149	0.5152
11	3089K	0.5174	0.5169	0.5166	0.5165	0.5162	0.5159	0.5162
12	3091K	0.5186	0.5185	0.5180	0.5179	0.5177	0.5174	0.5177
13	3127K	0.5193	0.5190	0.5187	0.5185	0.5183	0.5180	0.5183
14	3117K	0.5214	0.5211	0.5208	0.5206	0.5204	0.5201	0.5204
15	3085K	0.5183	0.5180	0.5176	0.5175	0.5173	0.5170	0.5173
16	3096K	0.5179	0.5176	0.5173	0.5171	0.5169	0.5166	0.5169
17	3106K	0.5179	0.5177	0.5173	0.5172	0.5169	0.5167	0.5169
18	3081K	0.5182	0.5180	0.5177	0.5175	0.5172	0.5170	0.5172
19	3100K	0.5187	0.5184	0.5180	0.5179	0.5176	0.5173	0.5176
20	3082K	0.5176	0.5173	0.5169	0.5168	0.5165	0.5162	0.5165
21	2961K	0.5232	0.5230	0.5226	0.5225	0.5222	0.5218	0.5222
22	3101K	0.5183	0.5180	0.5176	0.5175	0.5172	0.5168	0.5172
23	3099K	0.5167	0.5163	0.5161	0.5159	0.5156	0.5152	0.5156
24	3121K	0.5166	0.5164	0.5161	0.5159	0.5157	0.5153	0.5157
25	3107K	0.5174	0.5171	0.5168	0.5166	0.5163	0.5159	0.5163

Delta u'v' data for tested units

$T_s = T_{air} = 105^\circ\text{C}$, $I_f = 65\text{mA}$; $T_s \geq 103^\circ\text{C}$ and $T_{air} \geq 100^\circ\text{C}$ in compliance with LM-80-15

	CCT (t=0)	0hrs	1000hrs	2000hrs	3000hrs	4000hrs	5000hrs	6000hrs
1	3114K	0.0000	0.0004	0.0005	0.0009	0.0012	0.0014	0.0012
2	3090K	0.0000	0.0004	0.0007	0.0009	0.0012	0.0014	0.0012
3	3109K	0.0000	0.0004	0.0006	0.0007	0.0012	0.0014	0.0012
4	3118K	0.0000	0.0004	0.0006	0.0009	0.0013	0.0014	0.0013
5	2947K	0.0000	0.0005	0.0008	0.0009	0.0013	0.0014	0.0013
6	3104K	0.0000	0.0004	0.0007	0.0009	0.0013	0.0015	0.0013
7	2920K	0.0000	0.0004	0.0007	0.0009	0.0014	0.0015	0.0014
8	3117K	0.0000	0.0006	0.0008	0.0010	0.0014	0.0015	0.0014
9	3117K	0.0000	0.0002	0.0005	0.0008	0.0012	0.0014	0.0012
10	3126K	0.0000	0.0005	0.0007	0.0009	0.0013	0.0015	0.0013
11	3089K	0.0000	0.0006	0.0009	0.0009	0.0014	0.0016	0.0014
12	3091K	0.0000	0.0002	0.0006	0.0007	0.0011	0.0013	0.0011
13	3127K	0.0000	0.0004	0.0006	0.0009	0.0012	0.0014	0.0012
14	3117K	0.0000	0.0004	0.0007	0.0009	0.0012	0.0014	0.0012
15	3085K	0.0000	0.0005	0.0008	0.0009	0.0013	0.0014	0.0013
16	3096K	0.0000	0.0005	0.0007	0.0009	0.0013	0.0014	0.0013
17	3106K	0.0000	0.0004	0.0007	0.0008	0.0013	0.0013	0.0013
18	3081K	0.0000	0.0004	0.0005	0.0008	0.0013	0.0013	0.0013
19	3100K	0.0000	0.0005	0.0008	0.0009	0.0014	0.0016	0.0014
20	3082K	0.0000	0.0004	0.0007	0.0009	0.0013	0.0015	0.0013
21	2961K	0.0000	0.0004	0.0006	0.0008	0.0013	0.0016	0.0013
22	3101K	0.0000	0.0004	0.0008	0.0009	0.0014	0.0017	0.0014
23	3099K	0.0000	0.0005	0.0006	0.0009	0.0013	0.0016	0.0013
24	3121K	0.0000	0.0004	0.0006	0.0008	0.0012	0.0014	0.0012
25	3107K	0.0000	0.0004	0.0007	0.0009	0.0014	0.0017	0.0014

Forward Voltage [V] data for tested units

$T_s = T_{air} = 105^\circ\text{C}$, $I_f = 65\text{mA}$; $T_s \geq 103^\circ\text{C}$ and $T_{air} \geq 100^\circ\text{C}$ in compliance with LM-80-15

	CCT (t=0)	0hrs	1000hrs	2000hrs	3000hrs	4000hrs	5000hrs	6000hrs
1	3114K	5.603	5.609	5.604	5.613	5.609	5.607	5.607
2	3090K	5.596	5.579	5.571	5.582	5.576	5.578	5.573
3	3109K	5.593	5.604	5.590	5.604	5.596	5.836	5.596
4	3118K	5.581	5.800	5.583	5.604	5.645	5.674	5.583
5	2947K	5.627	5.585	5.588	5.657	5.586	5.588	5.593
6	3104K	5.565	5.565	5.559	5.572	5.680	5.577	5.561
7	2920K	5.614	5.596	5.600	5.613	5.608	5.600	5.596
8	3117K	5.595	5.783	5.595	5.610	5.771	5.601	5.599
9	3117K	5.645	5.837	5.587	5.598	5.589	5.587	5.583
10	3126K	5.557	5.570	5.583	5.565	5.583	5.669	5.558
11	3089K	5.565	6.797	5.560	5.569	5.563	5.565	5.559
12	3091K	5.556	5.619	5.928	5.571	5.564	5.566	5.560
13	3127K	5.587	5.748	5.579	5.840	5.580	5.584	5.580
14	3117K	5.623	5.599	5.612	5.845	5.615	5.601	5.601
15	3085K	5.567	5.564	5.562	5.628	5.604	5.569	5.579
16	3096K	5.592	5.608	5.555	5.571	5.558	5.570	5.579
17	3106K	5.580	5.554	5.550	5.564	5.553	5.562	5.552
18	3081K	5.592	5.781	5.595	5.611	5.594	5.610	5.593
19	3100K	5.842	5.593	5.617	5.658	5.600	5.597	5.593
20	3082K	5.598	5.620	5.714	5.612	5.611	5.613	5.602
21	2961K	5.619	5.602	5.605	5.617	5.603	5.608	5.624
22	3101K	5.623	5.602	5.597	5.607	5.599	5.602	5.598
23	3099K	5.574	5.592	5.581	5.592	5.580	5.578	5.576
24	3121K	5.575	5.626	5.580	5.578	5.572	5.571	5.568
25	3107K	5.577	5.671	5.707	5.722	5.589	5.587	5.582

Luminous Flux [lm] data for tested units

$T_s = T_{air} = 85^{\circ}\text{C}$, $I_f = 100\text{mA}$; $T_s \geq 83^{\circ}\text{C}$ and $T_{air} \geq 80^{\circ}\text{C}$ in compliance with LM-80-15

	CCT (t=0)	0hrs	1000hrs	2000hrs	3000hrs	4000hrs	5000hrs	6000hrs
1	3118K	108.400	108.700	108.600	108.300	108.200	108.000	107.700
2	3111K	109.300	109.100	108.900	108.800	108.700	108.400	108.200
3	3129K	107.000	106.900	106.700	106.600	106.500	106.300	105.900
4	3129K	108.700	108.500	108.300	108.100	107.900	107.600	107.400
5	3134K	106.900	106.800	106.700	106.600	106.400	106.100	105.900
6	3131K	106.400	106.000	105.800	105.700	105.600	105.300	105.200
7	3109K	108.100	107.900	107.700	107.600	107.400	107.200	106.900
8	3124K	108.700	108.600	108.400	108.300	108.100	107.900	107.800
9	3130K	107.500	107.600	107.400	107.200	107.000	106.800	106.600
10	3131K	107.900	107.800	107.700	107.400	107.200	106.900	106.700
11	3078K	105.900	106.100	106.000	105.800	105.700	105.500	105.200
12	3086K	109.000	108.800	108.500	108.300	108.100	107.900	107.600
13	3162K	109.700	109.300	109.100	109.000	108.800	108.600	108.300
14	3123K	107.400	107.300	107.000	106.900	106.800	106.600	106.300
15	3150K	108.400	108.100	108.000	107.700	107.500	107.300	107.000
16	3148K	108.400	108.000	107.700	107.600	107.400	107.100	106.900
17	3128K	107.700	107.400	107.200	107.000	106.900	106.700	106.400
18	3103K	107.700	107.600	107.300	107.100	107.000	106.700	106.500
19	3132K	109.300	109.000	108.800	108.700	108.500	108.400	108.200
20	3099K	107.000	106.700	106.600	106.400	106.300	106.000	105.600
21	3114K	106.600	106.200	106.100	105.800	105.600	105.400	105.100
22	3088K	107.900	107.800	107.700	107.500	107.300	107.000	106.700
23	3141K	108.400	108.500	108.200	108.100	107.900	107.600	107.500
24	3116K	108.400	108.300	108.100	107.900	107.800	107.500	107.300
25	3121K	107.200	107.000	106.700	106.600	106.400	106.300	106.100

Normalized Luminous Flux data for tested units

$T_s = T_{air} = 85^{\circ}\text{C}$, $I_f = 100\text{mA}$; $T_s \geq 83^{\circ}\text{C}$ and $T_{air} \geq 80^{\circ}\text{C}$ in compliance with LM-80-15

	CCT (t=0)	0hrs	1000hrs	2000hrs	3000hrs	4000hrs	5000hrs	6000hrs
1	3118K	1.000	1.003	1.002	0.999	0.998	0.996	0.994
2	3111K	1.000	0.998	0.996	0.995	0.995	0.992	0.990
3	3129K	1.000	0.999	0.997	0.996	0.995	0.993	0.990
4	3129K	1.000	0.998	0.996	0.994	0.993	0.990	0.988
5	3134K	1.000	0.999	0.998	0.997	0.995	0.993	0.991
6	3131K	1.000	0.996	0.994	0.993	0.992	0.990	0.989
7	3109K	1.000	0.998	0.996	0.995	0.994	0.992	0.989
8	3124K	1.000	0.999	0.997	0.996	0.994	0.993	0.992
9	3130K	1.000	1.001	0.999	0.997	0.995	0.993	0.992
10	3131K	1.000	0.999	0.998	0.995	0.994	0.991	0.989
11	3078K	1.000	1.002	1.001	0.999	0.998	0.996	0.993
12	3086K	1.000	0.998	0.995	0.994	0.992	0.990	0.987
13	3162K	1.000	0.996	0.995	0.994	0.992	0.990	0.987
14	3123K	1.000	0.999	0.996	0.995	0.994	0.993	0.990
15	3150K	1.000	0.997	0.996	0.994	0.992	0.990	0.987
16	3148K	1.000	0.996	0.994	0.993	0.991	0.988	0.986
17	3128K	1.000	0.997	0.995	0.994	0.993	0.991	0.988
18	3103K	1.000	0.999	0.996	0.994	0.994	0.991	0.989
19	3132K	1.000	0.997	0.995	0.995	0.993	0.992	0.990
20	3099K	1.000	0.997	0.996	0.994	0.993	0.991	0.987
21	3114K	1.000	0.996	0.995	0.992	0.991	0.989	0.986
22	3088K	1.000	0.999	0.998	0.996	0.994	0.992	0.989
23	3141K	1.000	1.001	0.998	0.997	0.995	0.993	0.992
24	3116K	1.000	0.999	0.997	0.995	0.994	0.992	0.990
25	3121K	1.000	0.998	0.995	0.994	0.993	0.992	0.990

CIE 1976 u' data for tested units

$T_s = T_{air} = 85^{\circ}\text{C}$, $I_f = 100\text{mA}$; $T_s \geq 83^{\circ}\text{C}$ and $T_{air} \geq 80^{\circ}\text{C}$ in compliance with LM-80-15

	CCT (t=0)	0hrs	1000hrs	2000hrs	3000hrs	4000hrs	5000hrs	6000hrs
1	3118K	0.2467	0.2463	0.2462	0.2463	0.2458	0.2459	0.2460
2	3111K	0.2468	0.2465	0.2466	0.2467	0.2461	0.2462	0.2463
3	3129K	0.2464	0.2461	0.2462	0.2462	0.2457	0.2458	0.2460
4	3129K	0.2463	0.2459	0.2460	0.2460	0.2454	0.2456	0.2457
5	3134K	0.2461	0.2458	0.2459	0.2460	0.2454	0.2455	0.2457
6	3131K	0.2467	0.2461	0.2463	0.2464	0.2458	0.2459	0.2461
7	3109K	0.2469	0.2465	0.2465	0.2468	0.2461	0.2463	0.2464
8	3124K	0.2463	0.2461	0.2460	0.2462	0.2456	0.2457	0.2458
9	3130K	0.2467	0.2463	0.2464	0.2466	0.2460	0.2462	0.2463
10	3131K	0.2460	0.2457	0.2457	0.2459	0.2454	0.2455	0.2456
11	3078K	0.2482	0.2474	0.2474	0.2476	0.2471	0.2472	0.2472
12	3086K	0.2480	0.2475	0.2476	0.2478	0.2473	0.2474	0.2473
13	3162K	0.2447	0.2444	0.2445	0.2445	0.2441	0.2441	0.2442
14	3123K	0.2465	0.2464	0.2465	0.2465	0.2460	0.2462	0.2462
15	3150K	0.2454	0.2452	0.2452	0.2453	0.2448	0.2449	0.2449
16	3148K	0.2453	0.2449	0.2450	0.2451	0.2445	0.2447	0.2449
17	3128K	0.2461	0.2458	0.2459	0.2459	0.2455	0.2456	0.2459
18	3103K	0.2471	0.2469	0.2470	0.2470	0.2465	0.2466	0.2468
19	3132K	0.2460	0.2456	0.2457	0.2457	0.2453	0.2453	0.2456
20	3099K	0.2476	0.2472	0.2473	0.2473	0.2469	0.2470	0.2472
21	3114K	0.2469	0.2465	0.2466	0.2467	0.2461	0.2463	0.2465
22	3088K	0.2481	0.2479	0.2479	0.2480	0.2474	0.2476	0.2479
23	3141K	0.2456	0.2453	0.2453	0.2454	0.2449	0.2451	0.2453
24	3116K	0.2468	0.2465	0.2465	0.2465	0.2461	0.2462	0.2464
25	3121K	0.2467	0.2464	0.2465	0.2465	0.2460	0.2461	0.2464

CIE 1976 v' data for tested units

$T_s = T_{air} = 85^{\circ}\text{C}$, $I_f = 100\text{mA}$; $T_s \geq 83^{\circ}\text{C}$ and $T_{air} \geq 80^{\circ}\text{C}$ in compliance with LM-80-15

	CCT (t=0)	0hrs	1000hrs	2000hrs	3000hrs	4000hrs	5000hrs	6000hrs
1	3118K	0.5184	0.5177	0.5174	0.5171	0.5169	0.5166	0.5163
2	3111K	0.5191	0.5188	0.5185	0.5182	0.5181	0.5178	0.5174
3	3129K	0.5180	0.5177	0.5174	0.5171	0.5170	0.5166	0.5162
4	3129K	0.5184	0.5180	0.5177	0.5175	0.5173	0.5170	0.5165
5	3134K	0.5184	0.5181	0.5179	0.5176	0.5175	0.5171	0.5167
6	3131K	0.5167	0.5162	0.5159	0.5156	0.5154	0.5152	0.5148
7	3109K	0.5189	0.5185	0.5183	0.5179	0.5178	0.5175	0.5170
8	3124K	0.5190	0.5187	0.5185	0.5181	0.5180	0.5177	0.5172
9	3130K	0.5168	0.5165	0.5163	0.5160	0.5158	0.5156	0.5151
10	3131K	0.5192	0.5190	0.5188	0.5185	0.5184	0.5181	0.5176
11	3078K	0.5185	0.5181	0.5179	0.5175	0.5175	0.5172	0.5166
12	3086K	0.5182	0.5178	0.5176	0.5173	0.5172	0.5169	0.5164
13	3162K	0.5196	0.5193	0.5191	0.5188	0.5187	0.5183	0.5178
14	3123K	0.5185	0.5183	0.5179	0.5177	0.5176	0.5173	0.5168
15	3150K	0.5188	0.5185	0.5182	0.5179	0.5179	0.5176	0.5170
16	3148K	0.5194	0.5190	0.5188	0.5186	0.5185	0.5181	0.5182
17	3128K	0.5192	0.5188	0.5185	0.5182	0.5182	0.5179	0.5179
18	3103K	0.5190	0.5186	0.5184	0.5181	0.5180	0.5177	0.5176
19	3132K	0.5190	0.5186	0.5183	0.5180	0.5180	0.5177	0.5176
20	3099K	0.5178	0.5174	0.5171	0.5169	0.5168	0.5165	0.5164
21	3114K	0.5182	0.5178	0.5175	0.5173	0.5172	0.5169	0.5168
22	3088K	0.5175	0.5172	0.5169	0.5166	0.5165	0.5163	0.5162
23	3141K	0.5192	0.5189	0.5185	0.5183	0.5183	0.5180	0.5179
24	3116K	0.5183	0.5180	0.5177	0.5175	0.5174	0.5171	0.5170
25	3121K	0.5180	0.5176	0.5174	0.5171	0.5170	0.5168	0.5167

Delta u'v' data for tested units

$T_s = T_{air} = 85^{\circ}\text{C}$, $I_f = 100\text{mA}$; $T_s \geq 83^{\circ}\text{C}$ and $T_{air} \geq 80^{\circ}\text{C}$ in compliance with LM-80-15

	CCT (t=0)	0hrs	1000hrs	2000hrs	3000hrs	4000hrs	5000hrs	6000hrs
1	3118K	0.0000	0.0008	0.0011	0.0014	0.0017	0.0020	0.0022
2	3111K	0.0000	0.0004	0.0006	0.0009	0.0012	0.0014	0.0018
3	3129K	0.0000	0.0004	0.0006	0.0009	0.0012	0.0015	0.0018
4	3129K	0.0000	0.0006	0.0008	0.0009	0.0014	0.0016	0.0020
5	3134K	0.0000	0.0004	0.0005	0.0008	0.0011	0.0014	0.0017
6	3131K	0.0000	0.0008	0.0009	0.0011	0.0016	0.0017	0.0020
7	3109K	0.0000	0.0006	0.0007	0.0010	0.0014	0.0015	0.0020
8	3124K	0.0000	0.0004	0.0006	0.0009	0.0012	0.0014	0.0019
9	3130K	0.0000	0.0005	0.0006	0.0008	0.0012	0.0013	0.0017
10	3131K	0.0000	0.0004	0.0005	0.0007	0.0010	0.0012	0.0016
11	3078K	0.0000	0.0009	0.0010	0.0012	0.0015	0.0016	0.0021
12	3086K	0.0000	0.0006	0.0007	0.0009	0.0012	0.0014	0.0019
13	3162K	0.0000	0.0004	0.0005	0.0008	0.0011	0.0014	0.0019
14	3123K	0.0000	0.0002	0.0006	0.0008	0.0010	0.0012	0.0017
15	3150K	0.0000	0.0004	0.0006	0.0009	0.0011	0.0013	0.0019
16	3148K	0.0000	0.0006	0.0007	0.0008	0.0012	0.0014	0.0013
17	3128K	0.0000	0.0005	0.0007	0.0010	0.0012	0.0014	0.0013
18	3103K	0.0000	0.0004	0.0006	0.0009	0.0012	0.0014	0.0014
19	3132K	0.0000	0.0006	0.0008	0.0010	0.0012	0.0015	0.0015
20	3099K	0.0000	0.0006	0.0008	0.0009	0.0012	0.0014	0.0015
21	3114K	0.0000	0.0006	0.0008	0.0009	0.0013	0.0014	0.0015
22	3088K	0.0000	0.0004	0.0006	0.0009	0.0012	0.0013	0.0013
23	3141K	0.0000	0.0004	0.0008	0.0009	0.0011	0.0013	0.0013
24	3116K	0.0000	0.0004	0.0007	0.0009	0.0011	0.0013	0.0014
25	3121K	0.0000	0.0005	0.0006	0.0009	0.0012	0.0013	0.0013

Forward Voltage [V] data for tested units

$T_s = T_{air} = 85^{\circ}\text{C}$, $I_f = 100\text{mA}$; $T_s \geq 83^{\circ}\text{C}$ and $T_{air} \geq 80^{\circ}\text{C}$ in compliance with LM-80-15

	CCT (t=0)	0hrs	1000hrs	2000hrs	3000hrs	4000hrs	5000hrs	6000hrs
1	3118K	5.742	6.466	5.754	5.757	5.751	5.755	5.745
2	3111K	5.765	5.773	5.800	5.782	5.767	5.771	5.771
3	3129K	5.721	5.720	5.951	5.737	5.730	5.723	5.720
4	3129K	5.815	5.793	5.796	5.900	5.810	5.831	5.790
5	3134K	5.763	5.766	5.764	5.781	5.868	5.778	5.776
6	3131K	5.786	6.164	5.922	5.790	5.746	5.747	5.744
7	3109K	5.775	5.782	5.782	5.811	5.782	6.069	5.787
8	3124K	5.771	5.808	5.825	5.819	5.829	5.778	5.792
9	3130K	5.732	5.741	6.137	5.746	5.738	5.739	5.739
10	3131K	5.952	5.810	5.820	5.798	5.882	5.783	5.781
11	3078K	5.827	5.773	5.770	5.781	5.895	5.767	5.765
12	3086K	5.722	5.744	5.729	5.763	5.728	5.732	5.727
13	3162K	5.786	5.822	5.788	5.801	5.809	5.788	5.788
14	3123K	5.721	5.722	5.727	5.736	5.729	5.728	5.934
15	3150K	5.751	5.752	5.749	5.761	5.755	5.760	5.869
16	3148K	5.734	5.889	5.741	5.755	5.744	5.743	5.741
17	3128K	5.755	5.760	5.766	5.772	5.761	5.751	5.751
18	3103K	5.720	5.956	5.726	5.755	5.728	5.732	5.726
19	3132K	5.776	5.888	5.745	5.755	5.910	5.758	5.742
20	3099K	5.821	5.792	5.731	5.744	5.731	5.735	5.730
21	3114K	5.772	5.730	5.709	5.726	5.708	5.718	5.711
22	3088K	5.869	5.753	5.735	5.758	5.837	5.743	5.744
23	3141K	5.736	5.807	5.740	5.752	5.741	5.748	5.741
24	3116K	5.774	5.798	5.775	5.753	5.745	5.760	5.744
25	3121K	5.732	5.737	5.732	5.748	5.733	5.738	5.738

Luminous Flux [lm] data for tested units

$T_s = T_{air} = 105^{\circ}\text{C}$, $I_f = 120\text{mA}$; $T_s \geq 103^{\circ}\text{C}$ and $T_{air} \geq 100^{\circ}\text{C}$ in compliance with LM-80-15

	CCT (t=0)	0hrs	1000hrs	2000hrs	3000hrs	4000hrs	5000hrs	6000hrs
1	3070K	125.800	125.500	125.200	124.900	124.500	124.300	124.100
2	3078K	125.600	125.400	125.300	125.100	124.900	124.700	124.400
3	3133K	127.500	127.100	126.800	126.500	126.100	125.700	125.600
4	3136K	125.300	125.000	124.800	124.600	124.300	123.900	123.700
5	2980K	127.400	127.500	127.100	127.000	126.500	126.400	126.000
6	3140K	124.900	125.100	124.700	124.600	124.300	124.100	123.900
7	3130K	126.700	126.800	126.500	126.200	126.000	125.600	125.200
8	3094K	127.200	127.000	126.500	126.400	126.100	125.800	125.500
9	3000K	127.200	127.100	126.700	126.500	126.300	125.800	125.400
10	3139K	127.100	126.800	126.500	126.400	126.100	125.700	125.400
11	3141K	128.300	128.100	127.800	127.400	127.300	127.000	126.600
12	3146K	128.400	127.900	127.500	127.200	127.000	126.800	126.400
13	3144K	120.200	120.000	119.600	119.400	119.100	118.900	118.800
14	3150K	125.800	125.900	125.400	125.100	124.900	124.600	124.200
15	3142K	127.800	127.600	127.200	127.000	126.700	126.400	125.900
16	3133K	126.900	126.800	126.400	126.000	125.800	125.500	125.200
17	3109K	126.800	126.900	126.500	126.100	125.800	125.600	125.400
18	3136K	124.700	124.400	124.100	124.000	123.600	123.300	123.000
19	3149K	127.100	126.600	126.200	126.100	125.900	125.500	125.000
20	3143K	125.900	125.600	125.400	125.200	124.700	124.400	124.100
21	3121K	122.500	122.600	122.300	122.000	121.800	121.400	121.100
22	3096K	124.600	124.000	123.800	123.600	123.400	123.000	122.600
23	3134K	127.000	126.800	126.600	126.400	125.900	125.600	125.200
24	3142K	126.000	125.900	125.600	125.300	125.000	124.800	124.400
25	3156K	127.700	127.400	127.300	127.100	126.800	126.500	126.300

Normalized Luminous Flux data for tested units

$T_s = T_{air} = 105^{\circ}\text{C}$, $I_f = 120\text{mA}$; $T_s \geq 103^{\circ}\text{C}$ and $T_{air} \geq 100^{\circ}\text{C}$ in compliance with LM-80-15

	CCT (t=0)	0hrs	1000hrs	2000hrs	3000hrs	4000hrs	5000hrs	6000hrs
1	3070K	1.000	0.998	0.995	0.993	0.990	0.988	0.986
2	3078K	1.000	0.998	0.998	0.996	0.994	0.993	0.990
3	3133K	1.000	0.997	0.995	0.992	0.989	0.986	0.985
4	3136K	1.000	0.998	0.996	0.994	0.992	0.989	0.987
5	2980K	1.000	1.001	0.998	0.997	0.993	0.992	0.989
6	3140K	1.000	1.002	0.998	0.998	0.995	0.994	0.992
7	3130K	1.000	1.001	0.998	0.996	0.994	0.991	0.988
8	3094K	1.000	0.998	0.994	0.994	0.991	0.989	0.987
9	3000K	1.000	0.999	0.996	0.994	0.993	0.989	0.986
10	3139K	1.000	0.998	0.995	0.994	0.992	0.989	0.987
11	3141K	1.000	0.998	0.996	0.993	0.992	0.990	0.987
12	3146K	1.000	0.996	0.993	0.991	0.989	0.988	0.984
13	3144K	1.000	0.998	0.995	0.993	0.991	0.989	0.988
14	3150K	1.000	1.001	0.997	0.994	0.993	0.990	0.987
15	3142K	1.000	0.998	0.995	0.994	0.991	0.989	0.985
16	3133K	1.000	0.999	0.996	0.993	0.991	0.989	0.987
17	3109K	1.000	1.001	0.998	0.994	0.992	0.991	0.989
18	3136K	1.000	0.998	0.995	0.994	0.991	0.989	0.986
19	3149K	1.000	0.996	0.993	0.992	0.991	0.987	0.983
20	3143K	1.000	0.998	0.996	0.994	0.990	0.988	0.986
21	3121K	1.000	1.001	0.998	0.996	0.994	0.991	0.989
22	3096K	1.000	0.995	0.994	0.992	0.990	0.987	0.984
23	3134K	1.000	0.998	0.997	0.995	0.991	0.989	0.986
24	3142K	1.000	0.999	0.997	0.994	0.992	0.990	0.987
25	3156K	1.000	0.998	0.997	0.995	0.993	0.991	0.989

CIE 1976 u' data for tested units

T_s = T_{air} = 105°C, I_f = 120mA; T_s ≥ 103°C and T_{air} ≥ 100°C in compliance with LM-80-15

	CCT (t=0)	0hrs	1000hrs	2000hrs	3000hrs	4000hrs	5000hrs	6000hrs
1	3070K	0.2487	0.2484	0.2486	0.2485	0.2480	0.2481	0.2485
2	3078K	0.2478	0.2469	0.2472	0.2468	0.2462	0.2463	0.2468
3	3133K	0.2459	0.2456	0.2458	0.2456	0.2452	0.2452	0.2458
4	3136K	0.2458	0.2453	0.2455	0.2454	0.2449	0.2450	0.2455
5	2980K	0.2504	0.2506	0.2504	0.2507	0.2502	0.2502	0.2503
6	3140K	0.2457	0.2452	0.2453	0.2453	0.2448	0.2449	0.2453
7	3130K	0.2462	0.2460	0.2461	0.2460	0.2456	0.2456	0.2459
8	3094K	0.2476	0.2473	0.2474	0.2473	0.2469	0.2470	0.2473
9	3000K	0.2495	0.2493	0.2494	0.2494	0.2489	0.2489	0.2493
10	3139K	0.2457	0.2456	0.2457	0.2456	0.2452	0.2453	0.2456
11	3141K	0.2458	0.2455	0.2457	0.2456	0.2452	0.2452	0.2455
12	3146K	0.2454	0.2452	0.2453	0.2453	0.2447	0.2448	0.2451
13	3144K	0.2452	0.2448	0.2450	0.2449	0.2445	0.2446	0.2449
14	3150K	0.2458	0.2457	0.2459	0.2457	0.2453	0.2454	0.2456
15	3142K	0.2449	0.2446	0.2448	0.2446	0.2443	0.2443	0.2446
16	3133K	0.2462	0.2459	0.2461	0.2460	0.2456	0.2457	0.2460
17	3109K	0.2466	0.2460	0.2462	0.2461	0.2455	0.2456	0.2459
18	3136K	0.2461	0.2457	0.2460	0.2458	0.2455	0.2455	0.2459
19	3149K	0.2453	0.2450	0.2452	0.2450	0.2446	0.2446	0.2449
20	3143K	0.2458	0.2456	0.2458	0.2457	0.2452	0.2453	0.2456
21	3121K	0.2464	0.2460	0.2463	0.2462	0.2458	0.2458	0.2461
22	3096K	0.2475	0.2472	0.2474	0.2471	0.2467	0.2467	0.2471
23	3134K	0.2456	0.2451	0.2454	0.2452	0.2448	0.2448	0.2452
24	3142K	0.2453	0.2450	0.2452	0.2450	0.2446	0.2446	0.2450
25	3156K	0.2455	0.2452	0.2453	0.2452	0.2448	0.2449	0.2452

CIE 1976 v' data for tested units

T_s = T_{air} = 105°C, I_f = 120mA; T_s ≥ 103°C and T_{air} ≥ 100°C in compliance with LM-80-15

	CCT (t=0)	0hrs	1000hrs	2000hrs	3000hrs	4000hrs	5000hrs	6000hrs
1	3070K	0.5179	0.5173	0.5169	0.5167	0.5167	0.5163	0.5160
2	3078K	0.5201	0.5192	0.5188	0.5184	0.5183	0.5179	0.5175
3	3133K	0.5192	0.5187	0.5183	0.5180	0.5180	0.5177	0.5174
4	3136K	0.5192	0.5186	0.5182	0.5180	0.5180	0.5176	0.5173
5	2980K	0.5252	0.5251	0.5245	0.5244	0.5244	0.5240	0.5235
6	3140K	0.5190	0.5181	0.5178	0.5175	0.5175	0.5170	0.5167
7	3130K	0.5186	0.5181	0.5178	0.5175	0.5175	0.5171	0.5167
8	3094K	0.5185	0.5180	0.5176	0.5173	0.5173	0.5169	0.5166
9	3000K	0.5255	0.5250	0.5247	0.5244	0.5245	0.5240	0.5236
10	3139K	0.5191	0.5187	0.5185	0.5181	0.5181	0.5176	0.5173
11	3141K	0.5185	0.5180	0.5177	0.5175	0.5174	0.5169	0.5166
12	3146K	0.5193	0.5190	0.5187	0.5184	0.5183	0.5178	0.5175
13	3144K	0.5203	0.5196	0.5192	0.5189	0.5189	0.5184	0.5181
14	3150K	0.5173	0.5170	0.5167	0.5164	0.5163	0.5160	0.5156
15	3142K	0.5216	0.5211	0.5210	0.5206	0.5206	0.5202	0.5198
16	3133K	0.5182	0.5178	0.5176	0.5173	0.5173	0.5169	0.5165
17	3109K	0.5201	0.5195	0.5193	0.5190	0.5189	0.5184	0.5180
18	3136K	0.5181	0.5176	0.5174	0.5171	0.5171	0.5167	0.5163
19	3149K	0.5193	0.5189	0.5187	0.5183	0.5183	0.5178	0.5175
20	3143K	0.5183	0.5179	0.5177	0.5173	0.5173	0.5169	0.5165
21	3121K	0.5191	0.5186	0.5183	0.5180	0.5180	0.5175	0.5172
22	3096K	0.5186	0.5183	0.5180	0.5174	0.5174	0.5170	0.5166
23	3134K	0.5202	0.5197	0.5195	0.5191	0.5191	0.5187	0.5183
24	3142K	0.5202	0.5199	0.5196	0.5193	0.5193	0.5189	0.5185
25	3156K	0.5176	0.5172	0.5169	0.5165	0.5165	0.5160	0.5158

Delta u'v' data for tested units

$T_s = T_{air} = 105^{\circ}C, I_f = 120mA; T_s \geq 103^{\circ}C$ and $T_{air} \geq 100^{\circ}C$ in compliance with LM-80-15

	CCT (t=0)	0hrs	1000hrs	2000hrs	3000hrs	4000hrs	5000hrs	6000hrs
1	3070K	0.0000	0.0007	0.0010	0.0012	0.0014	0.0017	0.0019
2	3078K	0.0000	0.0013	0.0014	0.0020	0.0024	0.0027	0.0028
3	3133K	0.0000	0.0006	0.0009	0.0012	0.0014	0.0017	0.0018
4	3136K	0.0000	0.0008	0.0010	0.0013	0.0015	0.0018	0.0019
5	2980K	0.0000	0.0002	0.0007	0.0009	0.0008	0.0012	0.0017
6	3140K	0.0000	0.0010	0.0013	0.0016	0.0017	0.0022	0.0023
7	3130K	0.0000	0.0005	0.0008	0.0011	0.0013	0.0016	0.0019
8	3094K	0.0000	0.0006	0.0009	0.0012	0.0014	0.0017	0.0019
9	3000K	0.0000	0.0005	0.0008	0.0011	0.0012	0.0016	0.0019
10	3139K	0.0000	0.0004	0.0006	0.0010	0.0011	0.0016	0.0018
11	3141K	0.0000	0.0006	0.0008	0.0010	0.0013	0.0017	0.0019
12	3146K	0.0000	0.0004	0.0006	0.0009	0.0012	0.0016	0.0018
13	3144K	0.0000	0.0008	0.0011	0.0014	0.0016	0.0020	0.0022
14	3150K	0.0000	0.0003	0.0006	0.0009	0.0011	0.0014	0.0017
15	3142K	0.0000	0.0006	0.0006	0.0010	0.0012	0.0015	0.0018
16	3133K	0.0000	0.0005	0.0006	0.0009	0.0011	0.0014	0.0017
17	3109K	0.0000	0.0008	0.0009	0.0012	0.0016	0.0020	0.0022
18	3136K	0.0000	0.0006	0.0007	0.0010	0.0012	0.0015	0.0018
19	3149K	0.0000	0.0005	0.0006	0.0010	0.0012	0.0017	0.0018
20	3143K	0.0000	0.0004	0.0006	0.0010	0.0012	0.0015	0.0018
21	3121K	0.0000	0.0006	0.0008	0.0011	0.0013	0.0017	0.0019
22	3096K	0.0000	0.0004	0.0006	0.0013	0.0014	0.0018	0.0020
23	3134K	0.0000	0.0007	0.0007	0.0012	0.0014	0.0017	0.0019
24	3142K	0.0000	0.0004	0.0006	0.0009	0.0011	0.0015	0.0017
25	3156K	0.0000	0.0005	0.0007	0.0011	0.0013	0.0017	0.0018

Forward Voltage [V] data for tested units

$T_s = T_{air} = 105^{\circ}C, I_f = 120mA; T_s \geq 103^{\circ}C$ and $T_{air} \geq 100^{\circ}C$ in compliance with LM-80-15

	CCT (t=0)	0hrs	1000hrs	2000hrs	3000hrs	4000hrs	5000hrs	6000hrs
1	3070K	5.787	5.784	5.784	5.800	5.785	5.801	5.789
2	3078K	5.864	5.867	5.928	5.876	5.874	5.881	5.889
3	3133K	5.830	5.843	5.833	5.880	5.841	5.844	5.830
4	3136K	5.784	6.032	5.786	5.794	5.785	5.790	5.820
5	2980K	5.843	5.839	5.844	5.875	5.851	5.850	5.846
6	3140K	5.881	5.875	5.890	5.890	5.883	5.898	5.888
7	3130K	5.832	5.828	5.836	6.025	5.869	5.851	5.902
8	3094K	5.855	5.852	5.855	5.874	5.857	5.866	5.863
9	3000K	5.889	5.942	5.900	5.902	5.896	5.889	5.928
10	3139K	5.905	5.885	5.886	5.908	5.927	5.885	5.895
11	3141K	5.948	5.860	5.879	5.901	5.866	5.909	5.866
12	3146K	5.871	5.866	5.885	5.940	5.871	5.868	5.872
13	3144K	5.835	5.836	5.841	5.953	5.841	6.010	5.842
14	3150K	5.820	5.801	5.796	5.808	5.803	5.801	5.806
15	3142K	5.861	5.801	5.850	5.810	5.796	6.022	5.830
16	3133K	5.887	5.820	5.839	5.837	5.824	6.071	5.828
17	3109K	5.904	5.886	5.880	5.894	5.885	5.907	5.885
18	3136K	5.886	5.882	5.872	5.933	5.873	5.880	5.878
19	3149K	5.866	5.867	5.876	5.885	5.871	5.997	5.870
20	3143K	5.838	5.845	5.950	5.862	5.890	5.899	5.847
21	3121K	5.882	5.884	5.880	6.089	5.892	5.891	5.919
22	3096K	5.868	5.920	5.857	5.867	5.867	5.865	5.861
23	3134K	5.837	5.838	5.840	5.865	5.850	5.841	5.845
24	3142K	5.957	6.098	5.872	5.938	5.896	6.061	5.873
25	3156K	5.840	5.842	5.841	5.901	5.844	5.841	5.844

Disclaimer

Neither Lumileds Holding B.V. nor its affiliates shall be liable for any kind of loss of data or any other damages, direct, indirect or consequential, resulting from the use of the provided information and data. Although Lumileds Holding B.V. and/or its affiliates have attempted to provide the most accurate information and data, the materials and services information and data are provided "as is," and neither Lumileds Holding B.V. nor its affiliates warrants or guarantees the contents and correctness of the provided information and data. Lumileds Holding B.V. and its affiliates reserve the right to make changes without notice. You as user agree to this disclaimer and user agreement with the download or use of the provided materials, information and data.

Company Information

Lumileds is a leading provider of power LEDs for everyday lighting applications. The company's records for light output, efficacy and thermal management are direct results of the ongoing commitment to advancing solid-state lighting technology and enabling lighting solutions that are more environmentally friendly, help reduce CO2 emissions and reduce the need for power plant expansion. Lumileds LUXEON LEDs are enabling never before possible applications in outdoor lighting, shop lighting, home lighting, digital imaging, display and automotive lighting.

Lumileds is a fully integrated supplier, producing core LED material in all three base colors, (red, green, blue) and white. Lumileds has R & D centers in San Jose, California and in the Netherlands, and production capabilities in San Jose, Singapore and Penang, Malaysia. Founded in 1999, Lumileds is the high flux LED technology leader and is dedicated to bridging the gap between solid-state technology and the lighting world. More information about the company's LUXEON LED products and solid-state lighting technologies can be found at www.lumileds.com.